

一应用原理

传统保险丝作为过流保护，仅能保护一次，烧断了就需更换。而作为新型过流保护元件的可恢复保险丝具有过流保护，自动复原双重功能：

过流保护 JKPPTC 元件串接在电路中，正常情况下，呈低阻状态，保证电路正常工作；当电路发生短路或窜入异常大电流时，JKPPTC 元件的自热使其阻抗增加把电流限制到足够小，起到过电流保护作用。

自动复原 当产生过电流的故障得到排除，JKPPTC 元件自动复原到低阻状态。这既避免了维护更换，也避免了可能引起电路损坏的持续循环的开闭状态。JKPPTC 可恢复保险丝具有过流保护，自动复原双重功能的原因是由于其特殊的构造。JKPPTC 可恢复保险丝是又高分子聚合物及导电材料等混合制成。正常情况下，导电材料通过聚合物材料构成三维导电通道，JKPPTC 阻值很小；当有异常大电流通过时，JKPPTC 元件温度迅速上升，聚合物材料随即膨胀，使得导电通道断开，引起阻抗剧增，通过的电流变小，电路如同断开，达到保护目的。当异常大电流消失后，JKPPTC 的自热不足以维持其高阻状态，其阻抗又恢复到低阻状态。与传统保险丝相比，具有可自复，体积小，更坚实的优点。

二动作原理

JKPPTC 可恢复保险丝的动作原理是一种能量的动态平衡，流过 JKPPTC 元件的电流由于 JKPPTC 的关系产生热量，产生的热全部或部分散发到环境中，而没有散发出去的热便会提高 JKPPTC 元件的温度。正常工作时的温度较低，产生的热和散发的热达到平衡。JKPPTC 元件处于低阻状态，JKPPTC 不动作，当流过 JKPPTC 元件的电流增加或环境温度升高，但如果达到产生的热和散发的热的平衡时，JKPPTC 仍不动作。当电流或环境温度再提高时，JKPPTC 会达到较高的温度。若此时电流或环境温度继续再增加，产生的热量会大于散发出去的热量，使得 JKPPTC 元件温度骤增，在此阶段，很小的温度变化会造成阻值的大幅提高，这时 JKPPTC 元件处于高阻保护状态，阻抗的增加限制了电流，电流在很短时间内急剧下降，从而保护电路设备免受损坏，只要施加的电压所产生的热量足够 JKPPTC 元件散发出的热量，处于变化状态下 JKPPTC 元件便可以一直处于动作状态（高阻）。当施加的电压消失时，JKPPTC 便可以自动恢复了。

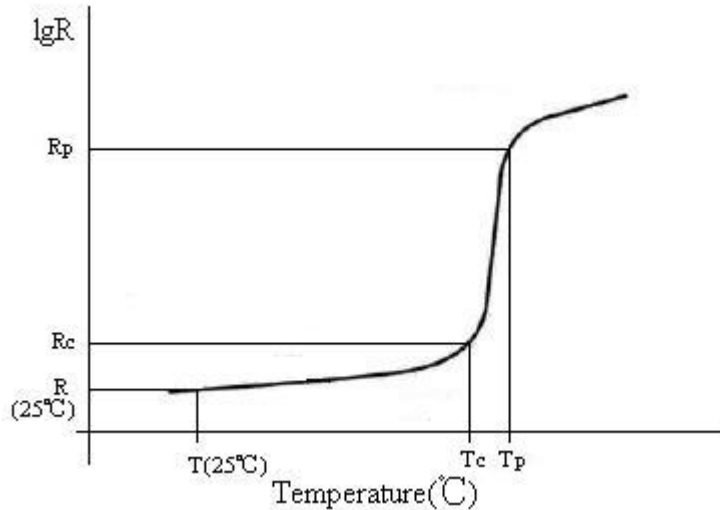

Rc: 开关电阻 Switch resistance

Rp: 最大工作电阻

Tc: 居里温度 Curie temperature

Tp: 最大工作温度 Maximum operational temperature

三环境温度影响

环境温度的提高在超过 25°C 时便会使通过可恢复保险丝的电流递减。环境温度 20°C 时线路上的电流 100% 通过可恢复保险丝，但若有超过两倍以上额定电流产生时，可恢复保险丝便会动作。环境温度越高通过的电流越大，则动作的时间会越短。环境温度与电流值折减率如下表所示：

规格	-20° C	-0° C	20° C	30° C	40° C	50° C	60° C	70° C	85° C
JK16 系列	132%	120%	105%	96%	88%	80%	71%	61%	47%
JK60 系列	136%	119%	100%	90%	81%	72%	63%	54%	40%
JK30 系列	130%	115%	100%	91%	83%	77%	68%	61%	52%
JK6 系列	130%	115%	115%	91%	83%	77%	68%	61%	52%
JK250 系列	132%	117%	100%	91%	85%	77%	68%	61%	48%
JK600 系列	138%	119%	100%	92%	83%	73%	64%	55%	42%
待续									

四产品分类

保持电流 (IH): 25°C 静止空气环境中不触发 PPTC 自复保险丝突越的最高电流。

触发电流 (IT): 25°C 静止空气环境中 PPTC 自复保险丝从低阻抗转为高阻抗的最小电流。

最大电压 (V max): PPTC 自复保险丝能承受的最大工作电压。

最大电流 (I max): P35 倍 PTC 自复保险丝能承受的最大电流。

动作时间 (T trip): 指定电流下的最大动作时间。

动作功率 (Pd typ): 25°C 环境温度时 PPTC 自复保险丝动作状态下的消耗功率。

最小电阻 (R min): 25°C 温度条件下最小零功率电阻。

最大电阻 (R max): 25°C 温度条件下最大零功率电阻。

1 JK250 系列

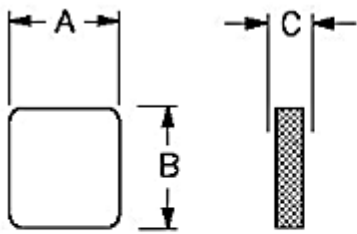

Figure 1

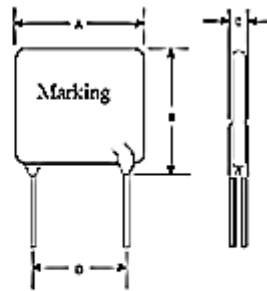

Figure 2

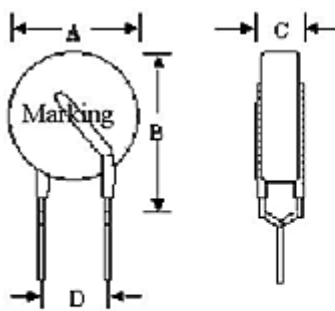

Figure 3

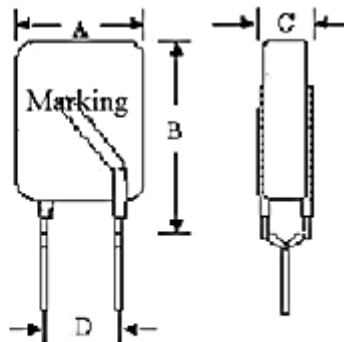

Figure 4

Model/PDF	V _{max} (V)	I _{max} (A)	I _h (mA)	R _{max} (Ω)	R _{min} (Ω)	Fig.	Maximum Contour Size (mm)			
							A	B	C	D
JK250-060V	250	3	60	40.0	26.0	3	6.0	9.3	3.8	5.1
JK250-080V	250	3	80	22.0	14.0	3	6.0	9.3	3.8	5.1
JK250-090V	250	3	90	20.0	10.0	3	6.0	9.3	3.8	5.1
JK250-110V	250	3	110	12.0	6.0	4	6.5	10.0	3.8	5.1
JK250-120	250	3	120	10.0	5.0	1	5.5	5.5	2.6	---
JK250-120V	250	3	120	10.0	6.0	4	7.0	10.0	3.8	5.1
JK250-145V	250	3	145	6.5	3.5	4	7.0	10.0	3.8	5.1
JK250-180T	250	10	180	2.2	1.0	3	10.2	14.5	3.4	5.1
JK250-180V	250	10	180	3.0	1.0	4	10.4	14.5	3.8	5.1
JK250-200V	250	10	200	6.0	3.0	2	10.5	17.0	3.8	5.1
JK250-400V	250	10	400	3.0	1.0	2	10.5	17.0	3.8	5.1
JK250-600V	250	10	600	2.0	0.6	2	16.0	18.0	4.5	5.1
JK250-800V	250	10	800	1.0	0.4	2	20.0	22.0	4.5	5.1

2 JK600 系列

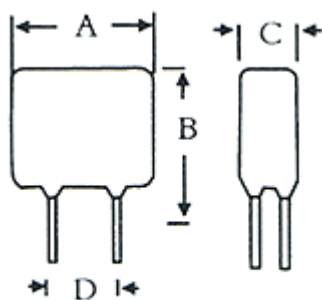

Figure 1

Model/PDF	V _{max} (V)	V _{max. inter} (V)	I _{max} (A)	I _h (mA)	R _{max} (Ω)	R _{min} (Ω)	Fig.	Maximum Contour Size (mm)			
								A	B	C	D
JK600-110V	60	600	3	110	14	7	1	14.0	14.0	6.0	5.1
JK600-150V	60	600	3	150	12	6	1	14.0	14.0	6.0	5.1
JK600-160V	60	600	3	160	10	4	1	14.0	14.0	6.0	5.1

3 JK90 系列

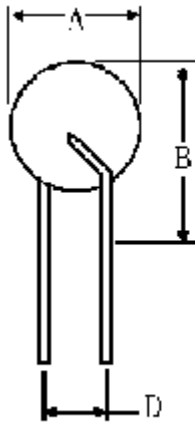

Figure 1

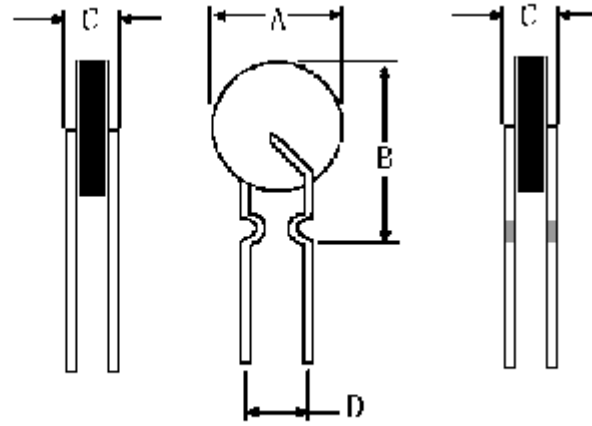

Figure 2

Model/PDF	I _h (A)	I _t (A)	V _{max} (V)	I _{max} (A)	Max. Time To Trip At 3*I _h (S)	P _d (W)	Initial resistance (Ω)		Fig
							R _{min}	R _{max}	
JK90-150	0.15	0.30	90	20	60	1.65	1.50	3.00	2
JK90-200	0.20	0.40	90	20	60	1.70	1.00	2.50	2
JK90-250	0.25	0.50	90	20	60	1.75	0.80	2.00	2
JK90-350	0.35	0.75	90	20	60	1.80	0.60	1.20	2
JK90-550I	0.55	1.10	90	20	60	2.00	0.30	0.90	1
JK90-550	0.55	1.10	90	20	60	2.00	0.35	0.90	2
JK90-750	0.75	1.50	90	20	60	2.50	0.20	0.60	2
JK90-900	0.90	1.80	90	20	60	3.00	0.10	0.50	2

Model	A (max)	B (max)	C (max)	D (max)
JK90-150	4.8	12.7	3.0	5.1
JK90-200	5.4	13.3	3.0	5.1
JK90-250	6.2	14.0	3.0	5.1
JK90-350	7.8	15.6	3.0	5.1
JK90-550	9.7	17.5	3.0	5.1
JK90-550I	9.7	17.5	3.0	5.1
JK90-750	11.2	19.0	3.0	5.1
JK90-900	12.8	20.5	3.0	5.1

4 JK60系列

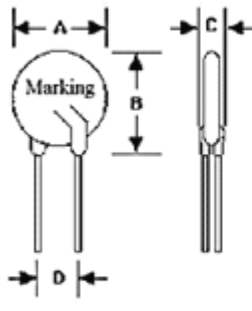

Figure 1

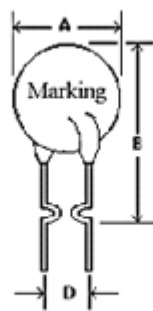

Figure 2

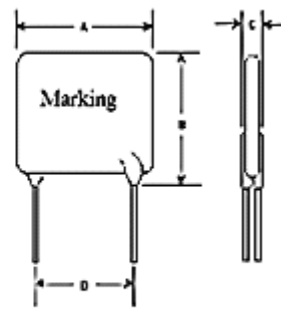

Figure 3

Model/PDF	V _{max} (V)	I _{max} (A)	I _h (A)	R _{max} (Ω)	R _{min} (Ω)	P _d (W)	Fig.	Maximum Contour Size (mm)			
								A	B	C	D
JK60-005	60	40	0.05	20.0	12.0	0.30	1	5.0	8.5	3.1	5.10
JK60-010	60	40	0.10	7.50	2.50	0.38	1	5.50	9.5	3.1	5.10
JK60-017	60	40	0.17	5.21	2.84	0.48	1	7.40	12.7	3.1	5.10
JK60-020	60	40	0.20	2.84	1.83	0.41	1	7.40	12.7	3.1	5.10
JK60-025	60	40	0.25	1.95	1.25	0.45	1	7.40	12.7	3.1	5.10
JK60-030	60	40	0.30	1.36	0.88	0.49	1	7.40	13.0	3.1	5.10
JK60-040	60	40	0.40	0.88	0.55	0.56	2	7.40	13.5	3.1	5.10
JK60-050	60	40	0.50	0.79	0.50	0.77	2	7.60	13.5	3.1	5.10
JK60-065	60	40	0.65	0.50	0.31	0.88	2	9.40	14.5	3.1	5.10
JK60-075	60	40	0.75	0.42	0.25	0.92	2	10.2	15.2	3.1	5.10
JK60-090	60	40	0.90	0.33	0.20	0.99	2	11.2	15.8	3.1	5.10
JK60-110-y	60	40	1.10	0.27	0.15	1.50	1	12.8	18.0	3.1	5.10
JK60-110-f	60	40	1.10	0.27	0.15	1.50	3	13.0	18.0	3.1	5.10
JK60-135	60	40	1.35	0.21	0.12	1.70	1	14.5	19.6	3.1	5.10
JK60-160	60	40	1.60	0.16	0.09	1.90	1	16.3	21.3	3.1	5.10
JK60-185	60	40	1.85	0.14	0.08	2.10	1	17.5	22.9	3.1	5.10
JK60-250	60	40	2.50	0.10	0.05	2.50	1	20.8	26.4	3.1	10.2
JK60-300	60	40	3.00	0.08	0.04	2.80	1	23.9	30.0	3.1	10.2
JK60-375	60	40	3.75	0.07	0.03	3.20	1	27.2	31.8	3.1	10.2
JK60-500	60	40	5.00	0.02	0.03	4.20	1	27.2	31.8	3.1	10.2

5 JK30系列

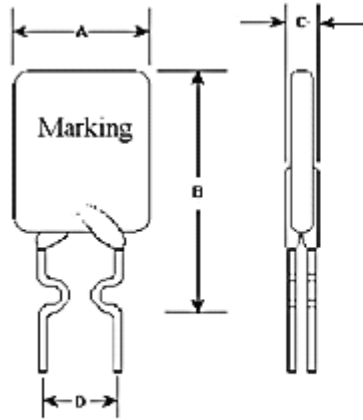

Figure 1

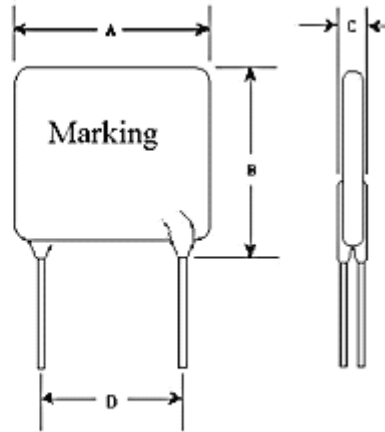
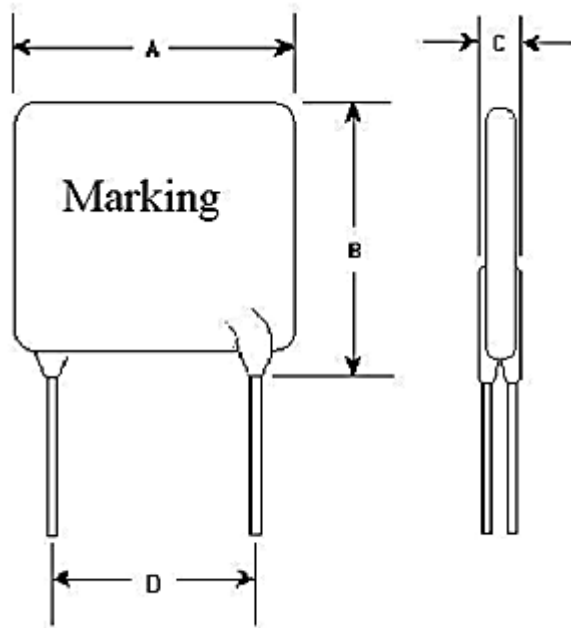

Figure 2

Model/PDF	Vmax (V)	Imax (A)	Ih (A)	Rmax (Ω)	Rmin (Ω)	Fig.	Pd(W)	Maximum Contour Size (mm)			
								A	B	C	D
JK30-090	30	40	0.90	0.22	0.130	1	0.60	7.40	12.2	3.1	5.10
JK30-110	30	40	1.10	0.20	0.090	1	0.70	7.40	12.2	3.1	5.10
JK30-135	30	40	1.35	0.16	0.070	1	0.80	9.20	13.5	3.1	5.10
JK30-160	30	40	1.60	0.14	0.060	1	0.90	9.20	15.2	3.1	5.10
JK30-185	30	40	1.85	0.12	0.050	1	1.00	9.20	15.2	3.1	5.10
JK30-200	30	40	2.00	0.10	0.040	1	1.20	15.2	15.2	3.1	5.10
JK30-250	30	40	2.50	0.08	0.030	1	1.20	13.2	18.3	3.1	5.10
JK30-300	30	40	3.00	0.07	0.030	2	2.00	13.2	17.3	3.1	5.10
JK30-400	30	40	4.00	0.06	0.010	2	2.50	14.0	20.1	3.1	5.10
JK30-500	30	40	5.00	0.05	0.010	2	3.00	14.0	20.1	3.1	10.2
JK30-600	30	40	6.00	0.04	0.005	2	3.50	17.2	24.9	3.1	10.2
JK30-700	30	40	7.00	0.03	0.005	2	3.80	17.2	24.9	3.1	10.2
JK30-800	30	40	8.00	0.025	0.005	2	4.00	23.5	29.2	3.1	10.2
JK30-900	30	40	9.00	0.02	0.005	2	4.20	23.5	29.2	3.1	10.2

6 JK16系列



Model/PDF	V_{max} (V)	I_{max} (A)	I_h (A)	R_{max} (m Ω)	R_{min} (m Ω)	P_d (W)
JK16-300	16	100	3.0	60	20	2.3
JK16-400	16	100	4.0	40	20	2.4
JK16-500	16	100	5.0	25	14	2.6
JK16-600	16	100	6.0	21	10	2.8
JK16-700	16	100	7.0	15	8	3.0
JK16-800	16	100	8.0	13	6	3.0
JK16-900	16	100	9.0	12	4	3.3
JK16-1000	16	100	10.0	11	4	3.7
JK16-1100	16	100	11.0	9	3	3.7
JK16-1200	16	100	12.0	8	3	4.2
JK16-1300	16	100	13.0	8	3	4.2
JK16-1400	16	100	14.0	6	3	4.6

Model	A (max)	B (max)	C (max)	D (max)
JK16-300	9.0	12.0	3.0	5.1
JK16-400	10.0	13.0	3.0	5.1
JK16-500	10.7	15.0	3.0	5.1
JK16-600	13.5	15.0	3.0	5.1
JK16-700	13.5	18.0	3.0	5.1
JK16-800	13.5	18.0	3.0	5.1
JK16-900	15.0	23.0	3.0	5.1
JK16-1000	18.0	24.0	3.0	5.1
JK16-1100	18.0	24.0	3.0	5.1
JK16-1200	22.5	25.0	3.0	10.2
JK16-1300	24.0	28.0	3.0	10.2
JK16-1400	24.0	28.0	3.0	10.2

7 JK6系列

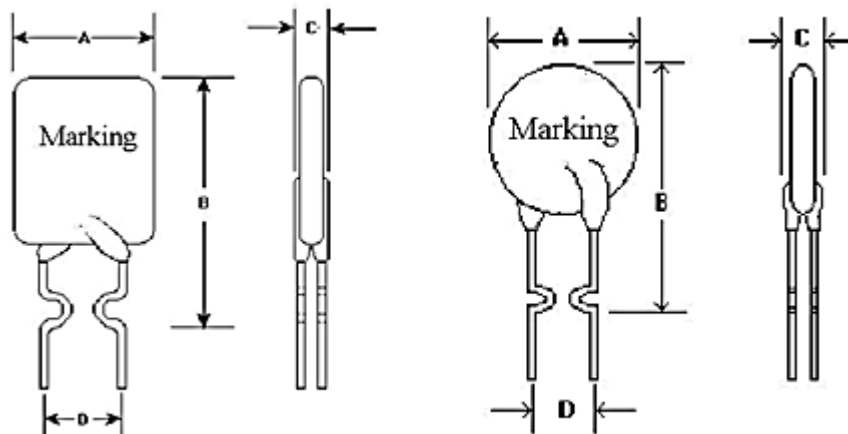

Model/PDF	Vmax (V)	Imax (A)	Ih (A)	Rmax (Ω)	Rmin (Ω)	Pd (W)	Fig.	Maximum Contour Size (mm)			
								A	B	C	D
JK6-075	6	40	0.75	0.50	0.20	0.3	2	7.40	12.7	3.10	5.10
JK6-090	16	40	0.90	0.30	0.10	0.6	2	7.40	13.0	3.10	5.10
JK6-110	16	40	1.10	0.27	0.10	0.7	1	7.80	13.0	3.10	5.10
JK6-120	6	40	1.20	0.22	0.12	0.6	2	7.40	13.5	3.10	5.10
JK6-135	16	40	1.35	0.18	0.07	0.8	2	7.40	13.5	3.10	5.10
JK6-155	6	40	1.55	0.16	0.06	0.8	2	7.40	13.5	3.10	5.10
JK6-160	16	40	1.60	0.16	0.05	0.9	1	7.80	16.0	3.10	5.10
JK6-185	16	40	1.85	0.13	0.04	1.0	1	7.80	16.0	3.10	5.10
JK6-250	16	40	2.50	0.08	0.02	1.2	1	10.0	16.0	3.10	5.10
JK6-300	16	40	3.00	0.07	0.02	1.2	1	10.0	16.5	3.10	5.10

8 贴片系列

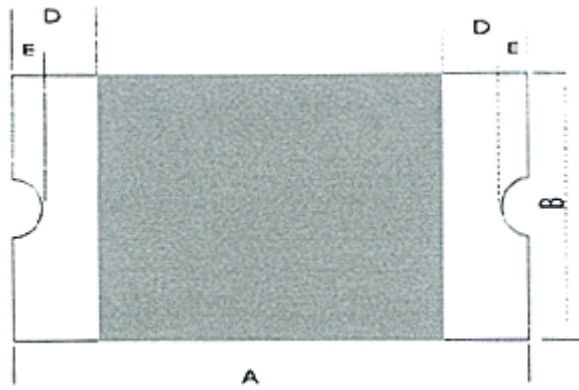

Model	V _{max} (V)	I _{max} (A)	I _h (A)	R _{max} (Ω)	R _{min} (Ω)	P _d (W)
JK-MSMD050	15.0	40	0.50	1.00	0.15	0.8
JK-MSMD075	13.2	40	0.75	0.45	0.11	0.8
JK-MSMD110	6.0	40	1.10	0.21	0.04	0.8
JK-MSMD125	6.0	40	1.25	0.18	0.05	0.8
JK-MSMD150	6.0	40	1.50	0.15	0.03	0.8
JK-MSMD160	6.0	40	1.60	0.06	0.02	0.8

Model	A (max)	B (max)	C (max)	D (max)	E (max)
JK-MSMD050	4.73	3.41	0.75	0.30	0.25
JK-MSMD075	4.73	3.41	0.75	0.30	0.25
JK-MSMD110	4.73	3.41	0.75	0.30	0.25
JK-MSMD125	4.73	3.41	1.25	0.30	0.25
JK-MSMD150	4.73	3.41	0.75	0.30	0.25
JK-MSMD160	4.73	3.41	0.75	0.30	0.25

9 JK-H 系列

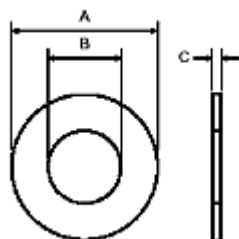

Part number	I_H (A)	I_T (A)	T_{trip}		V_{max} (V)	I_{max} (A)	R_{min} (Ω)	R_{max} (Ω)	R_{lmax} (Ω)
			Current (A)	Times (S)					
JK-H160-100	2.00	6.00	10.00	10	16	40	0.010	0.020	0.030
JK-H162-92	2.00	4.00	10.00	10	16	40	0.010	0.020	0.030
JK-H144-63	2.00	4.00	10.00	10	16	40	0.010	0.020	0.030
JK-H119-40	2.00	4.00	10.00	10	16	40	0.010	0.020	0.030

Part number	A		B		C	
	Min	Max	Min	Max	Min	Max
JK-H160-100	15.95	16.05	9.95	10.05	0.25	0.35
JK-H162-92	16.15	16.25	9.15	9.25	0.25	0.35
JK-H144-63	14.35	14.45	6.20	6.30	0.25	0.35
JK-H119-40	11.90	12.00	3.95	4.05	0.25	0.35